

INDEX+ 46 C/EW

Part number 3121563

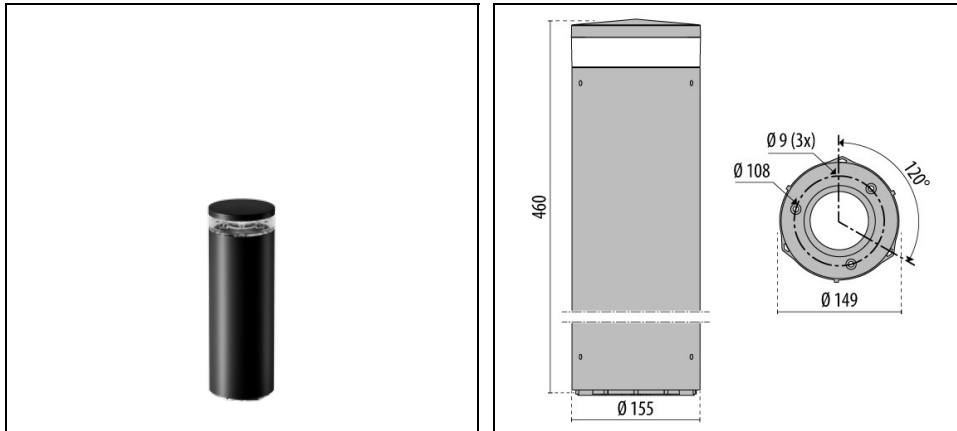

Description

Series of bollards, comprising:

- Die-cast aluminium cover painted prior chemical preparation of the surface
- UV stabilised transparent polycarbonate diffuser
- UV and heat stabilised high-transparency polycarbonate optics. The optical unit compartment features superior heat dissipation and IK10-rated impact resistance grating specific light distributions
- Aluminium heat sink
- Anti-ageing custom moulded silicone sealing gasket(s)
- Technopolymer cable compartment cover
- Stainless steel locking hardware
- Each luminaire is supplied with two IP 68 cable gland allowing a single or a through power connection
- Die-cast aluminium floor mount base polyester powder coat finish prior chemical surface conversion
- AISI 304 stainless steel sheet metal sturdy bases for floor mounting are available as accessories. For purpose illumination: promoting safe navigation through campuses, car parks and public spaces
- Concrete installation fixing rods are available as accessories. Compatible with standard die-cast aluminium and optional stainless steel heavy use (HU) baseplates

To maintain the regular updating of our products, PERFORMANCE IN LIGHTING reserves the right to make changes without prior notice. For the most up to date information we always recommend you read the latest version published on the website www.performanceinlighting.com. Delivered luminaire lumen outputs and power consumptions, including losses, are subject to a tolerance of +/- 7%, and unless otherwise stated the values apply to an ambient temperature of 25°C. Terms of warranty are available at <https://www.performanceinlighting.com/qr/company/led-warranty>

Product data

ETIM Group:	EG000027	ETIM Class:	EC000301
-------------	----------	-------------	----------

General information

Lampholder:	LED	Light source:	
Lightsource lumen output [lm]:	2250	Luminaire lumen output [lm]:	1605
Luminaire wattage [W]:	13 W	Luminous efficacy [lm/W]:	123
CRI:	80	Colour temperature [K]:	4000
Colour / Finishing:	BK-81 / Black / Textured	IP degree of protection:	IP65
IK-J-xxIP:	IK10 20J xxg	Protection class:	II
Optic:	C/EW - Circular Extra-Wide	Net weight [kg]:	3.731
Overall diameter [mm]:	154	Overall height [mm]:	460

Mechanical features

Shape:	Round 150 ≤ x ≤ 300 mm	Housing material:	Plastic
Diffuser material:	Transparent plastic	Glow wire test [°C]:	750 °C

Electrical features

Voltage type:	AC/DC	Input voltage [V AC]:	220/240
Input frequency [Hz]:	220-240V 50/60Hz	Power factor / COS Φ:	>0.95
Input voltage [V DC]:	170/280	Inrush current [A/μs]:	5 / 50
C10 1.5 mm ² :	52	C16 2.5 mm ² :	85
B10 1.5 mm ² :	31	B16 2.5 mm ² :	50

Installation

Application area:	Outdoor	Mounting type:	Bollards
Min. ambient temperature [°C]:	-20	Max. ambient temperature [°C]:	35

Light features

MacAdam:	3	Lumen maintenance:	L70B10@147000h
Distribution of light emission:	Direct	Luminous Intensity Class:	None
Zero light pollution (ULR = 0%):		IPEA* (road lighting):	A5+
IPEA* (large areas, roundabouts):	A6+	IPEA* (cycle-pedestrian):	A5+
IPEA* (green areas):	A5+	IPEA* (historic city centers):	A9+

To maintain the regular updating of our products, PERFORMANCE iN LIGHTING reserves the right to make changes without prior notice. For the most up to date information we always recommend you read the latest version published on the website www.performanceinlighting.com. Delivered luminaire lumen outputs and power consumptions, including losses, are subject to a tolerance of +/- 7%, and unless otherwise stated the values apply to an ambient temperature of 25°C. Terms of warranty are available at <https://www.performanceinlighting.com/qr/company/led-warranty>

Photometric data

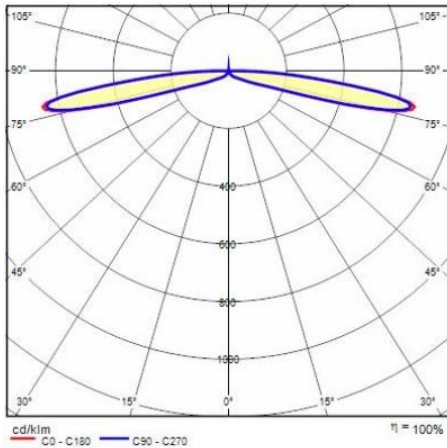

Optional accessories

INDEX+



3114401

AISI 316 stainless steel floor installation base

■ INOX / Stainless steel

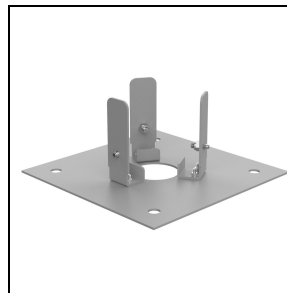

3114402

AISI 316 stainless steel floor installation base

■ INOX / Stainless steel



14049320

Concrete mounting adaptor with stainless steel plate and galvanised steel rods